

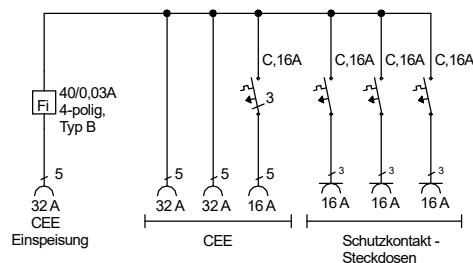

STEIDELE

STROMVERTEILER

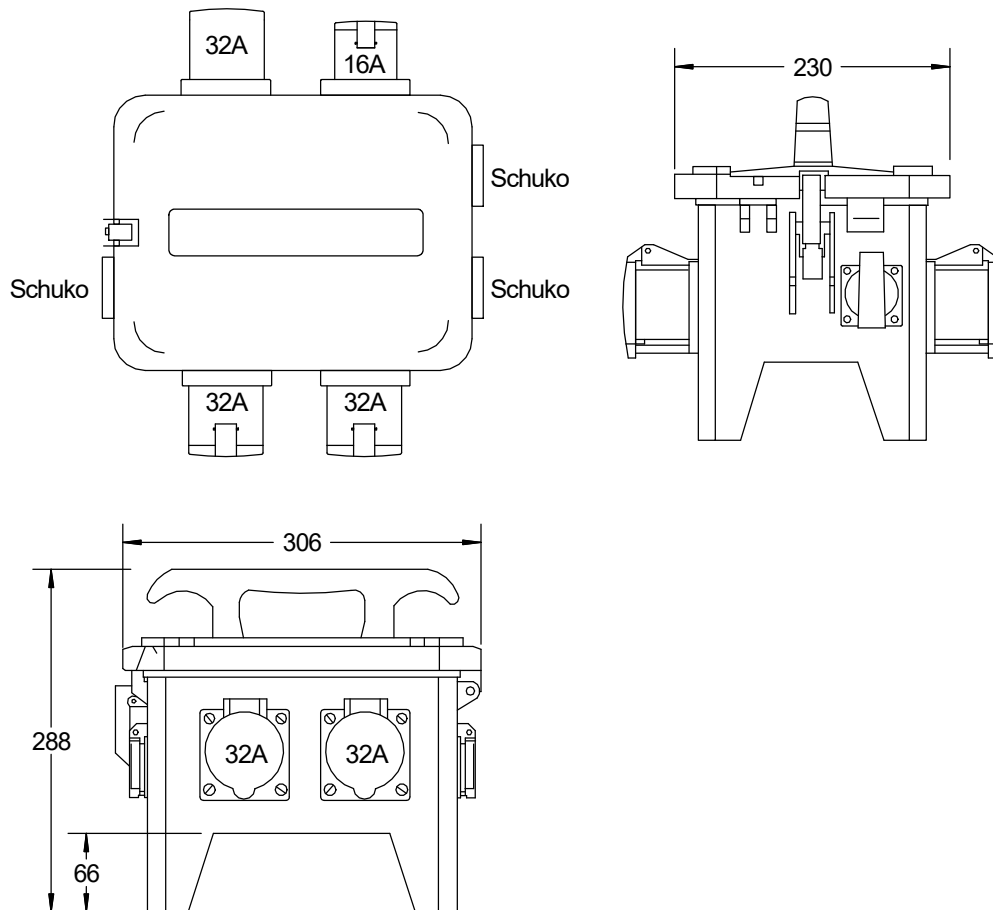

Entsprechend dem Entwurf der neuen DIN VDE 0100-704, 10/2018

Typ: SVG 32.1/12-3

Verteiler nach EN 61439-4

Leistung 22 kVA, Gewicht ca. 7,1 kg

Best.Nr. 9220

gezeichnet am/von:

05.06.2019 / Uffinger