

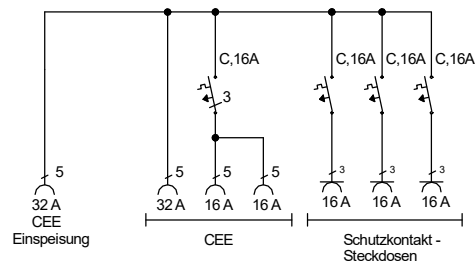

STEIDELE

STROMVERTEILER

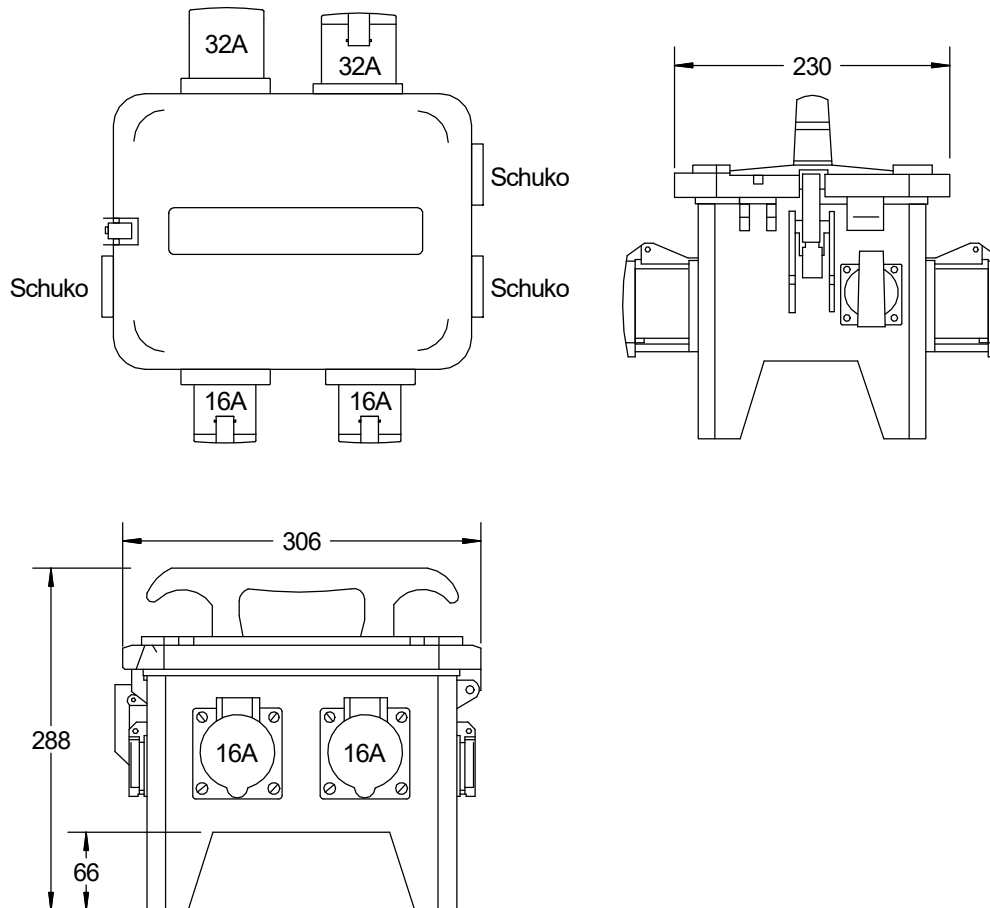
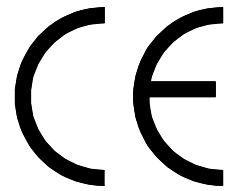

Entsprechend dem Entwurf der neuen DIN VDE 0100-704, Dezember 2016

Typ: SVG 32.0/21-3

Best.Nr. 9210

Verteiler nach EN 61439-4

gezeichnet am/von:

Leistung 22 kVA, Gewicht ca. 6,8 kg

05.06.2019 / Uffinger