

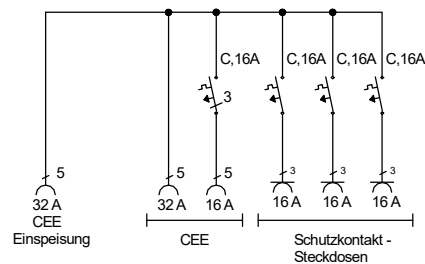

# STEIDELE

## STROMVERTEILER

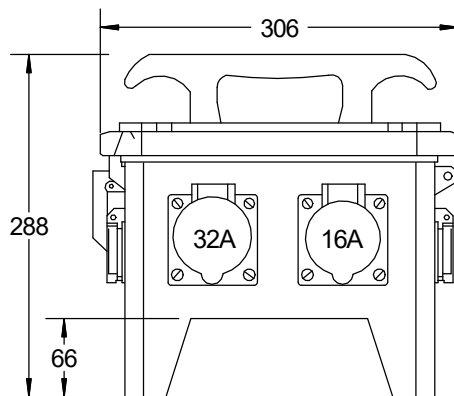
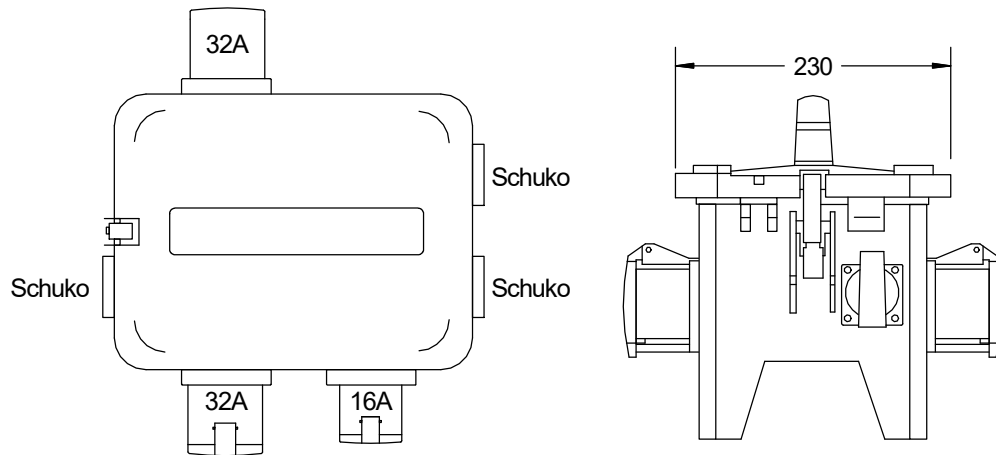
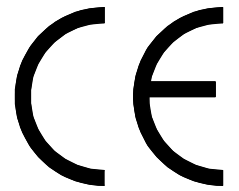

Entsprechend dem Entwurf der neuen DIN VDE 0100-704, Dezember 2016

Typ: SVG 32.0/11-3

Best.Nr. 9190

Verteiler nach EN 61439-4

gezeichnet am/von:

Leistung 22 kVA, Gewicht ca. 7,2 kg

05.06.2019 / Uffinger