

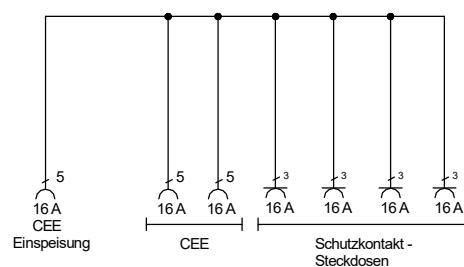

STEIDELE

STROMVERTEILER

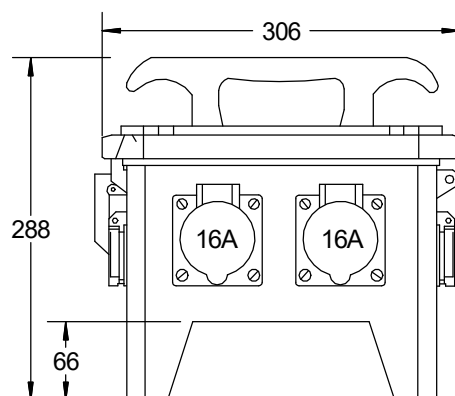
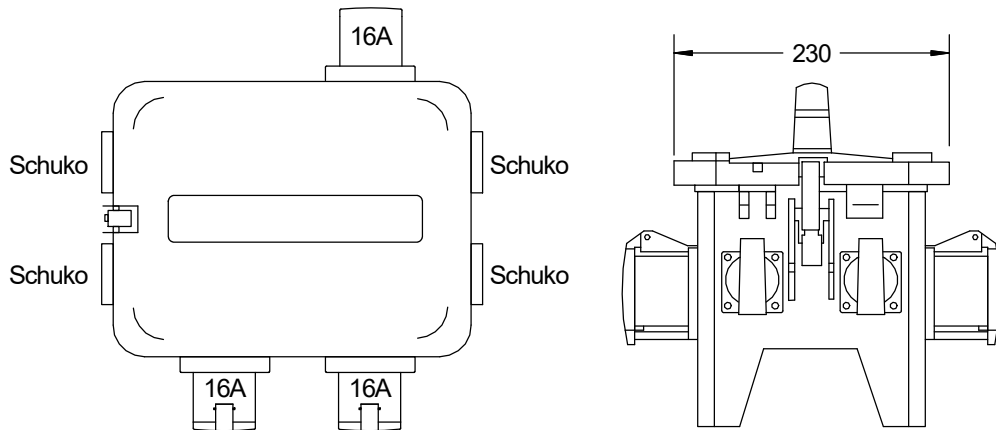
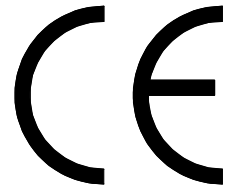

Entsprechend dem Entwurf der neuen DIN VDE 0100-704, 10/2018

Typ: SVG 16.0/2-4

Best.Nr. 9130

Verteiler nach EN 61439-4

gezeichnet am/von:

Leistung 11 kVA, Gewicht ca. 5,7 kg

05.06.2019 / Uffinger