

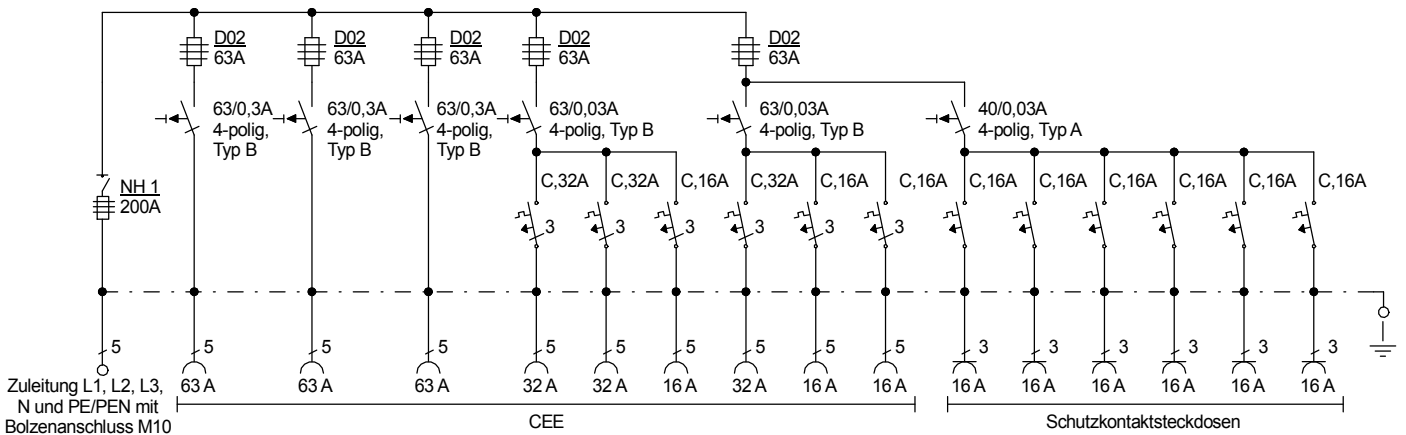

STEIDELE

STROMVERTEILER

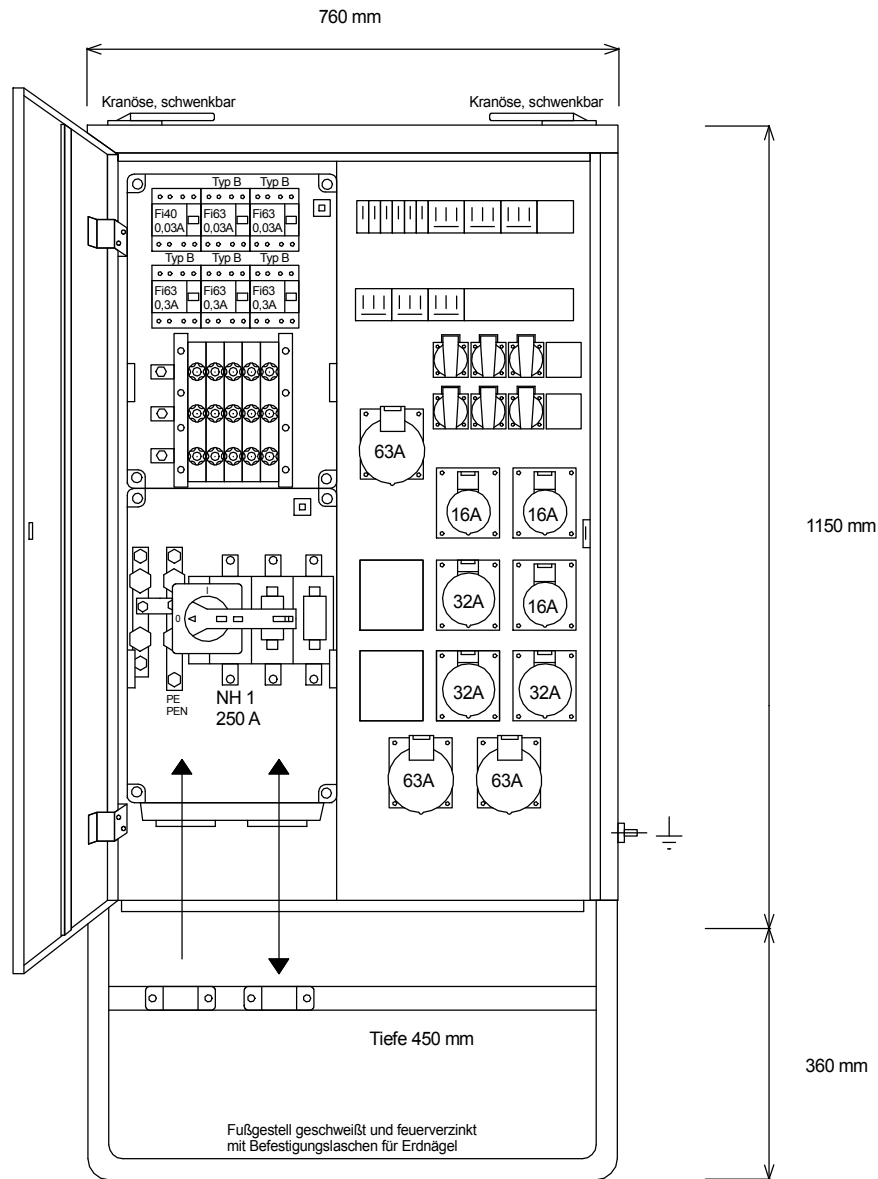

Entsprechend dem Entwurf der neuen DIN VDE 0100-704, Dezember 2016

Typ: V 200.6/333-6

Best.Nr. 7460

Verteiler nach EN 61439-4

gezeichnet am/von:

Leistung 138 kVA, Gewicht ca. 90 kg, Gehäuse 74

03.04.2017 / Uffinger