

STEIDELE - Baustromverteiler

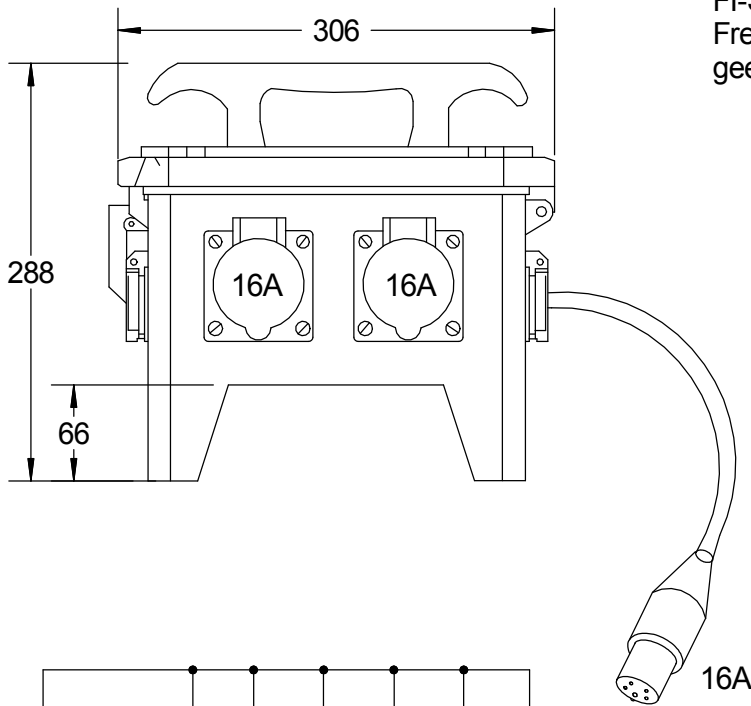

FI-Schalter Typ A sind nicht für den Betrieb Frequenzumrichter gesteuerter Betriebsmittel geeignet!

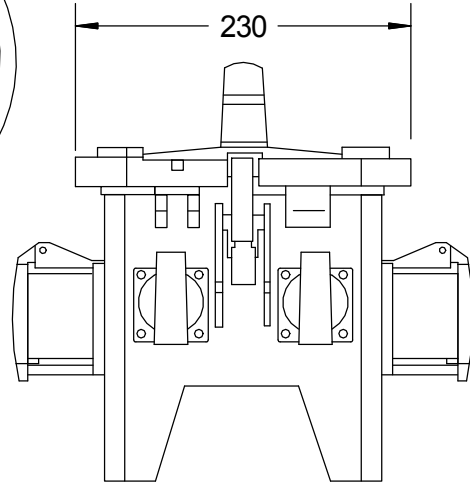
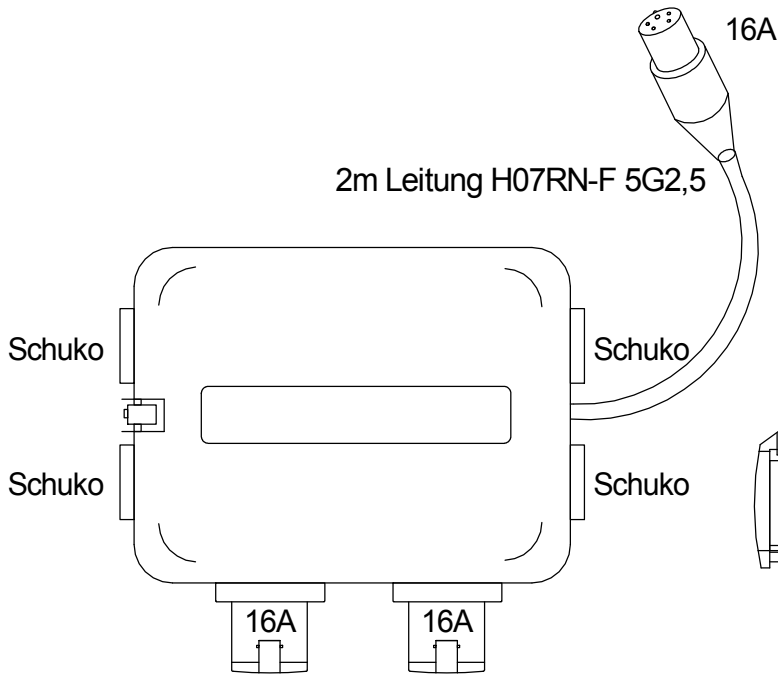
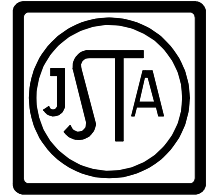
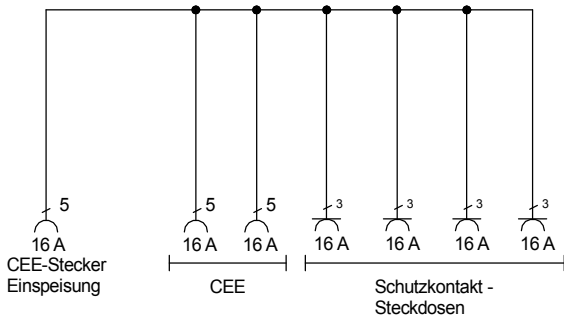

Typ:	SVG 16.0/2-4/STE	Nr. 6510
Artikelgruppe:	Vollgummi-Steckdosenverteiler nach EN 61439-1	gezeichnet am/von:
Leistung:	11 kVA	22.08.2016 / Uffinger