

STEIDELE - Baustromverteiler

CE

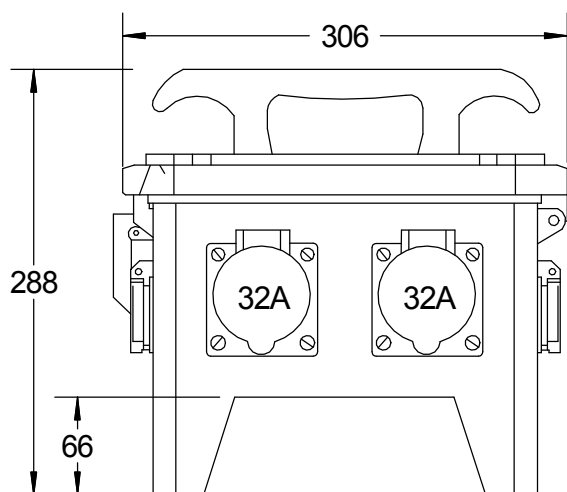

FI-Schalter Typ A sind nicht für den Betrieb Frequenzumrichter gesteuerter Betriebsmittel geeignet!

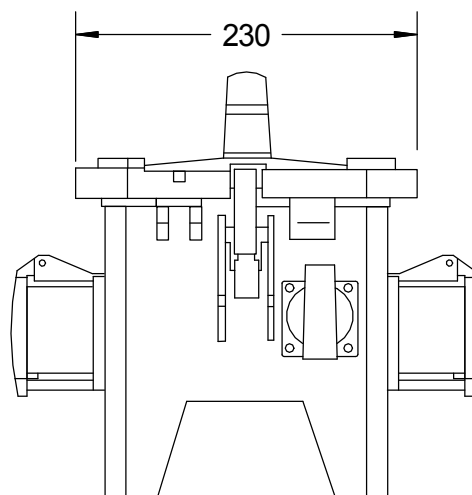
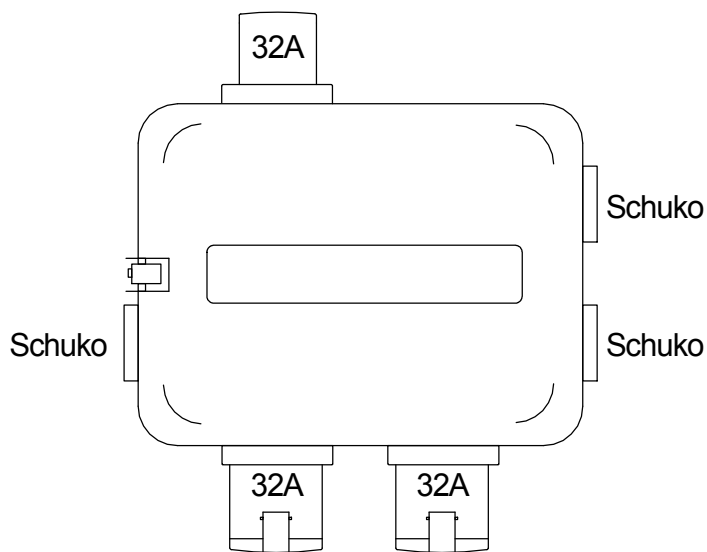
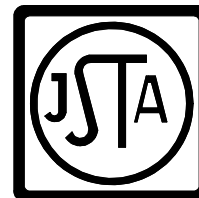
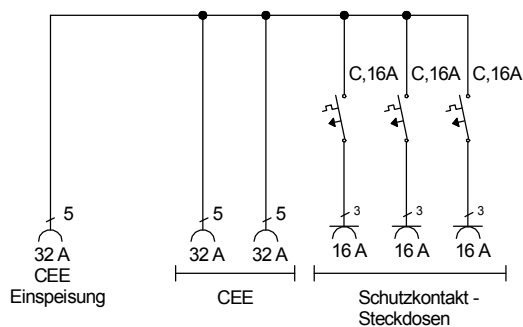

Typ:	SVG 32.1/02-3	Nr. 6170
Artikelgruppe:	Vollgummi-Steckdosenverteiler nach EN 61439-1	gezeichnet am/von:
Leistung:	22 kVA	22.08.2016 / Uffinger

