

STEIDELE - Baustromverteiler

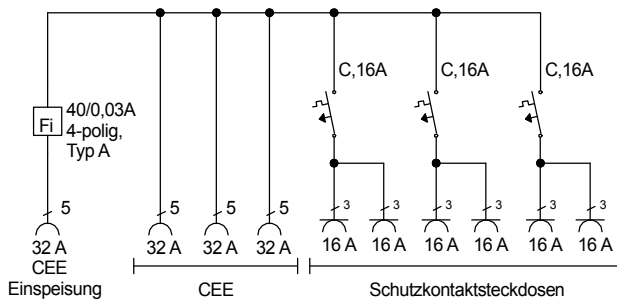
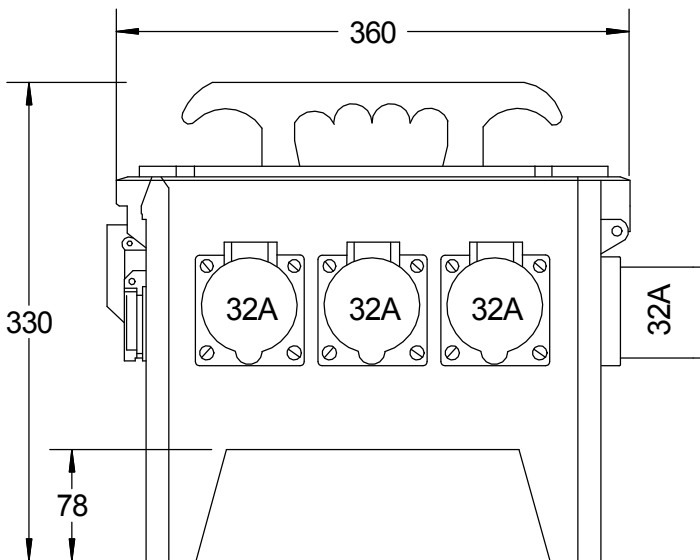
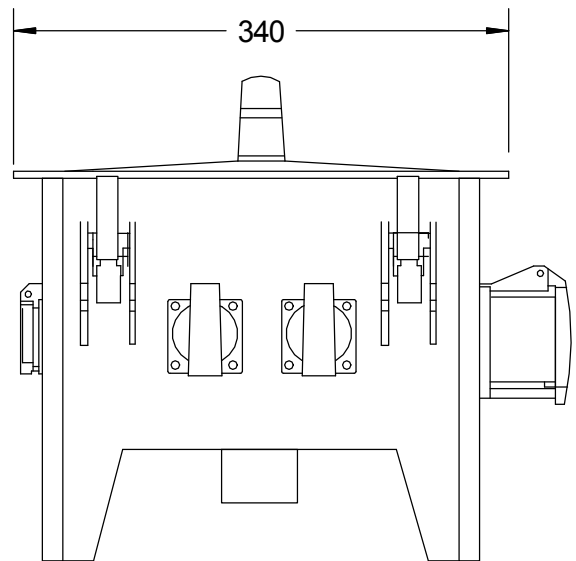
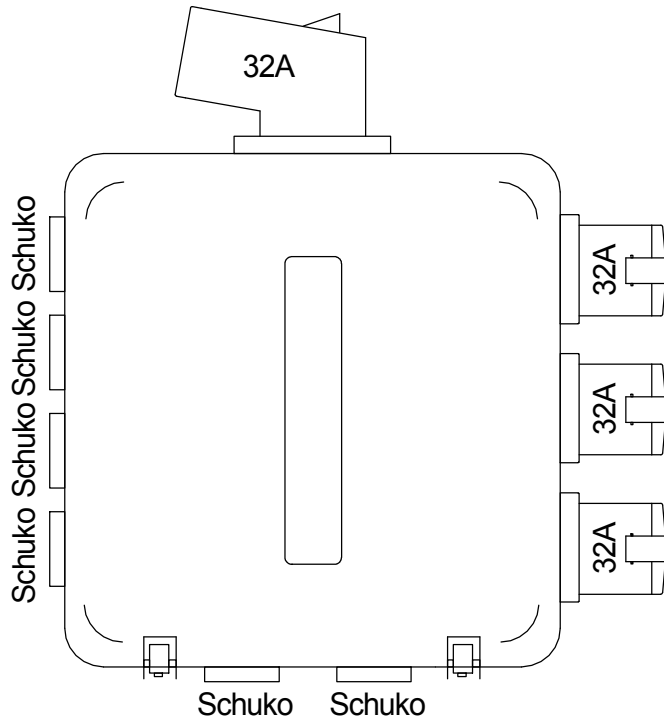
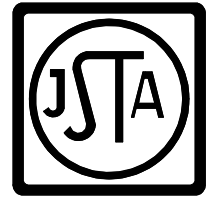

FI-Schalter Typ A sind nicht für den Betrieb Frequenzumrichter gesteuerter Betriebsmittel geeignet!

Typ:	SVG 32/03-6	Nr. 6022
Artikelgruppe:	Vollgummi-Steckdosenverteiler nach EN 61439-1	gezeichnet am/von:
Leistung:	22 kVA	24.08.2016 / Uffinger