

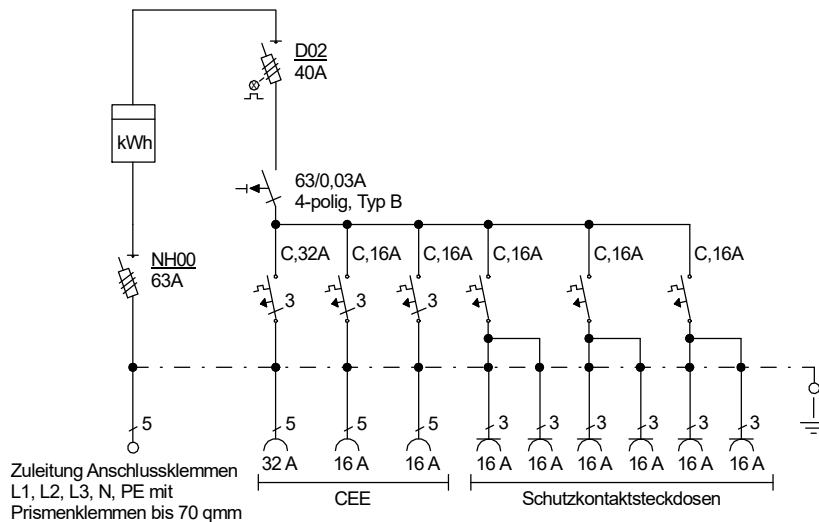

STEIDELE

Stromverteiler

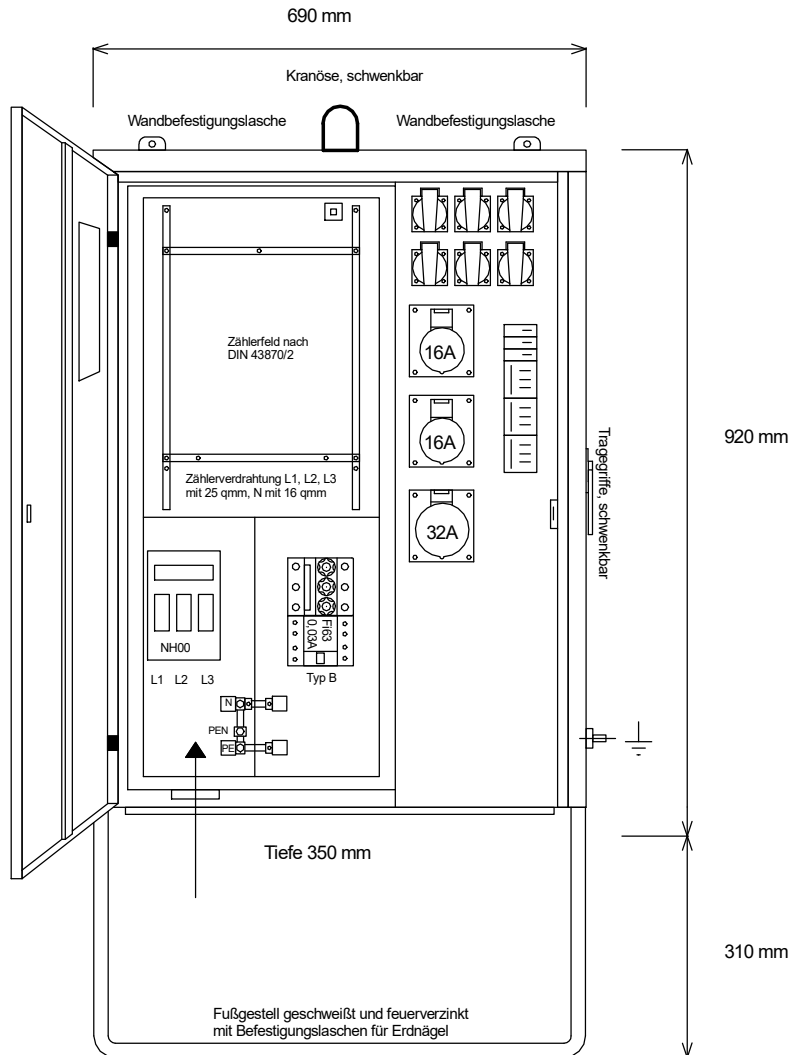
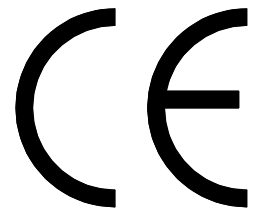

Entsprechend dem Entwurf der neuen DIN VDE 0100-704, 10/2018

Typ: AV 63.1/21-6-V

Anschluss-Verteiler nach EN 61439-4

Leistung 44 kVA, Gewicht ca. 51 kg, Gehäuse 71

Best.Nr. 1561

gezeichnet am/von:

23.10.2019 / Uffinger