

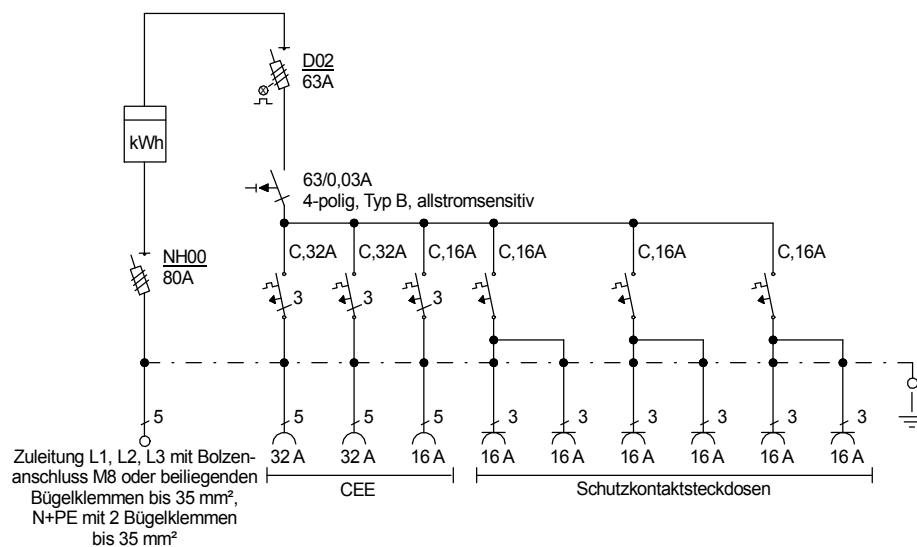

STEIDELE

STROMVERTEILER

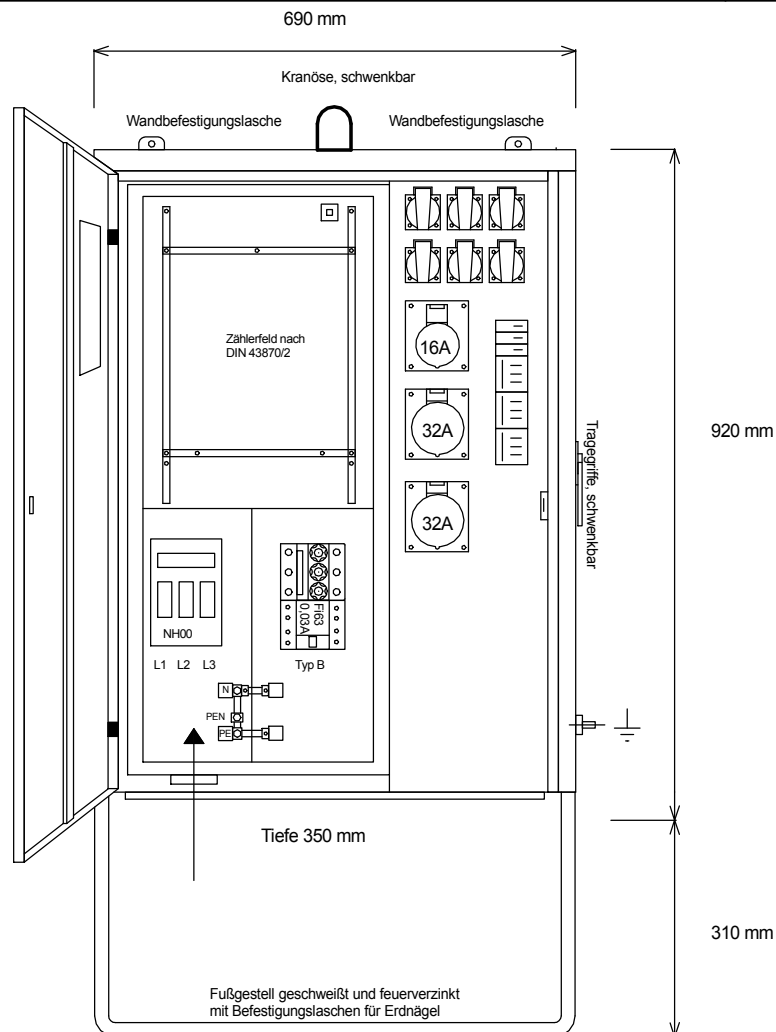

Entsprechend dem Entwurf der neuen DIN VDE 0100-704, Dezember 2016

Typ: AV 63/12-6

Anschluss-Verteiler nach EN 61439-4

Leistung 44 kVA, Gewicht ca. 51 kg, Gehäuse 71

Best.Nr. 1550

gezeichnet am/von:

21.03.2017 / Uffinger